

IQTOUCH

IQTouch QA1400 PRO

Powered by **EDLA-certified Android 14**,
delivers the freedom of Android with the
rock-solid security of Google.





Where Android 14 Innovation Meets Google-Trusted EDLA Security

Powered by Android 14.0 with Google EDLA certification, the QA1400 Pro delivers the best of both worlds — the openness of Android and the security of the Google ecosystem. Enjoy effortless access to Google Play apps, Workspace tools and seamless multi-account management, empowering teams to work smarter, faster and more securely than ever before.

Google EDLA

Teach and Collaborate with Google

Unlock endless possibilities with Google-powered tools designed for modern classrooms and collaborative work.



A World of Learning Apps

Securely download a wide range of educational and productivity apps from the official Google Play Store.



Advanced Google Security

Advanced Google security protects every account and every file, ensuring a safe environment for schools and organizations.

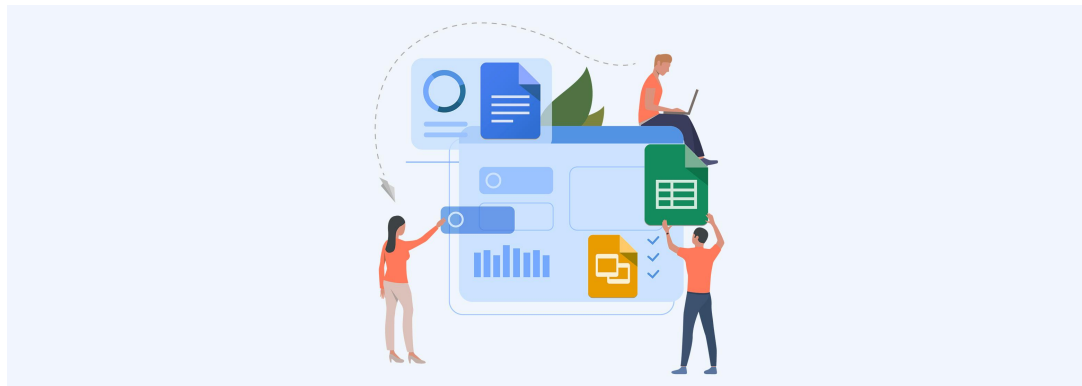

Real-Time Collaboration

Edit and share content together in Google Docs, Sheets and Slides. Multiple users can contribute at the same time for truly interactive teamwork.



Google Drive

Store and retrieve files directly from the cloud. Teachers and students can easily access learning materials anytime, anywhere.

Smart Interface at Your Fingertips

The QA1400 Pro makes every interaction effortless. Switch accounts instantly, access your favorite tools with a single touch and let the screen respond automatically as you approach. Every function is designed to be intuitive and convenient, so you can focus on what matters most.



NFC Card: Support binding NFC cards to Google accounts and effortlessly switching Google accounts with a simple tap.

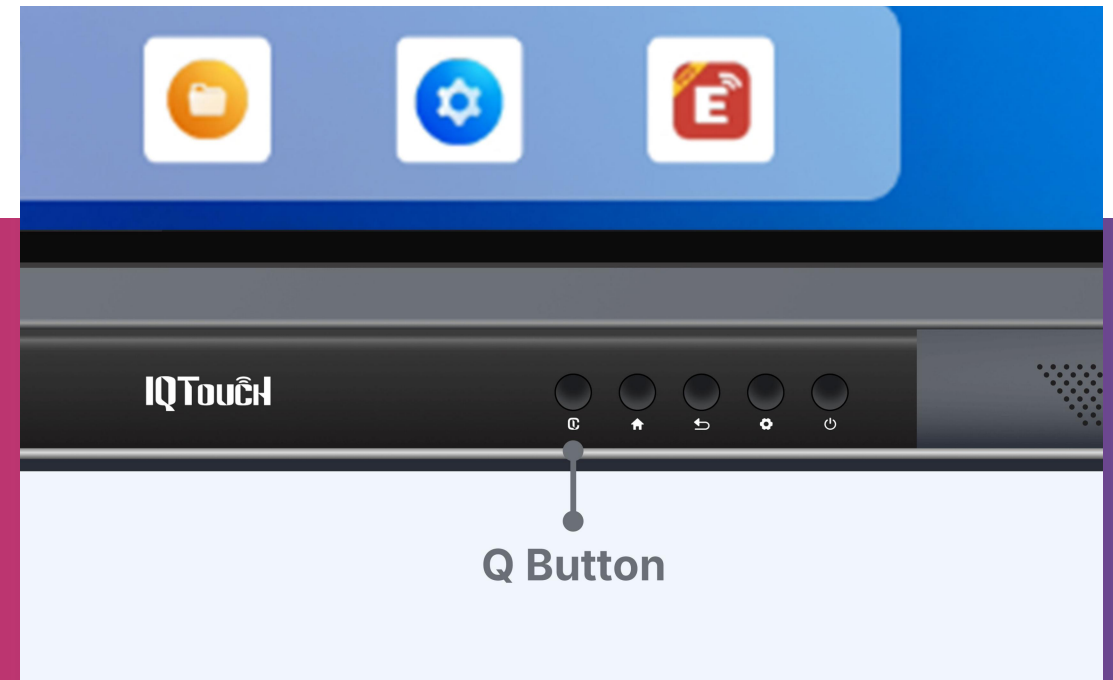

Q Button: Access your most-used tools across all input channels with Q button and tailor the button setting to suit your workflow.

Smart Interface at Your Fingertips



Proximity Sensor: Instantly springs to life when teachers or students come within 3 meters, creating a seamless and responsive learning environment.

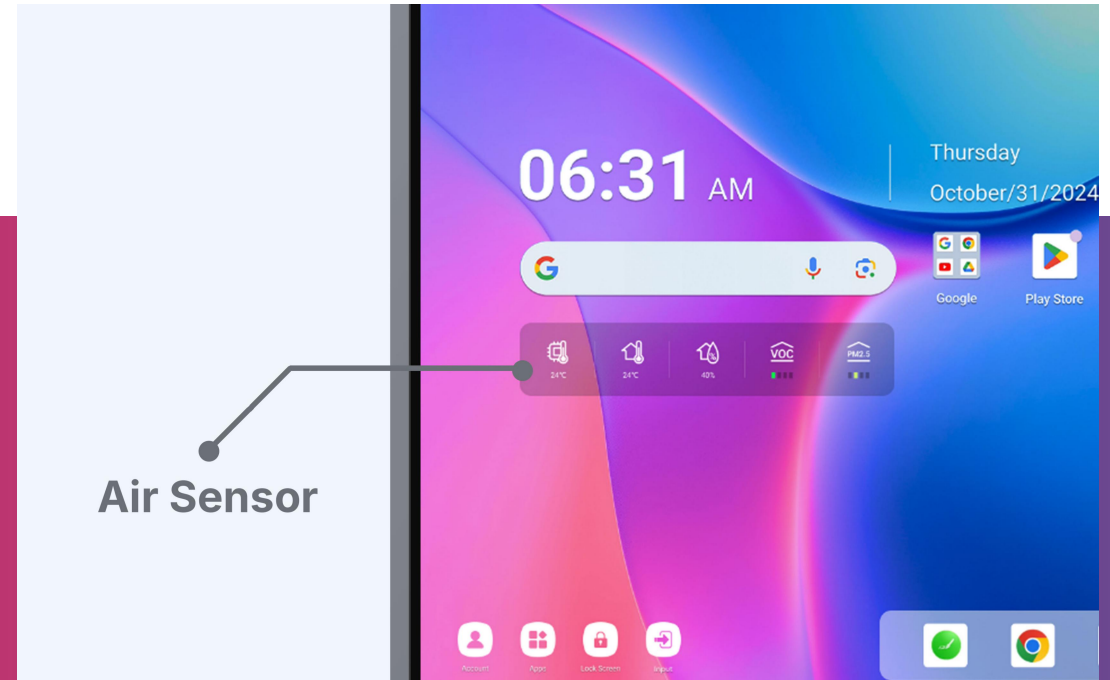

Air Sensor: Built-in air quality sensors for real-time monitoring of VOCs and PM2.5, helping presenters maintain optimal audience comfort and air quality.

Precise Writing and Touch, Perfected for Teaching

The QA1400 Pro combines zero-bonding technology with 50-point touch for ultra-responsive, paper-like writing. With 1mm touch accuracy, 2mm writing height and 1.5mm minimum touch object, you can write, draw and annotate effortlessly, even with your palm or elbow on the screen, for a seamless and creative interactive experience.

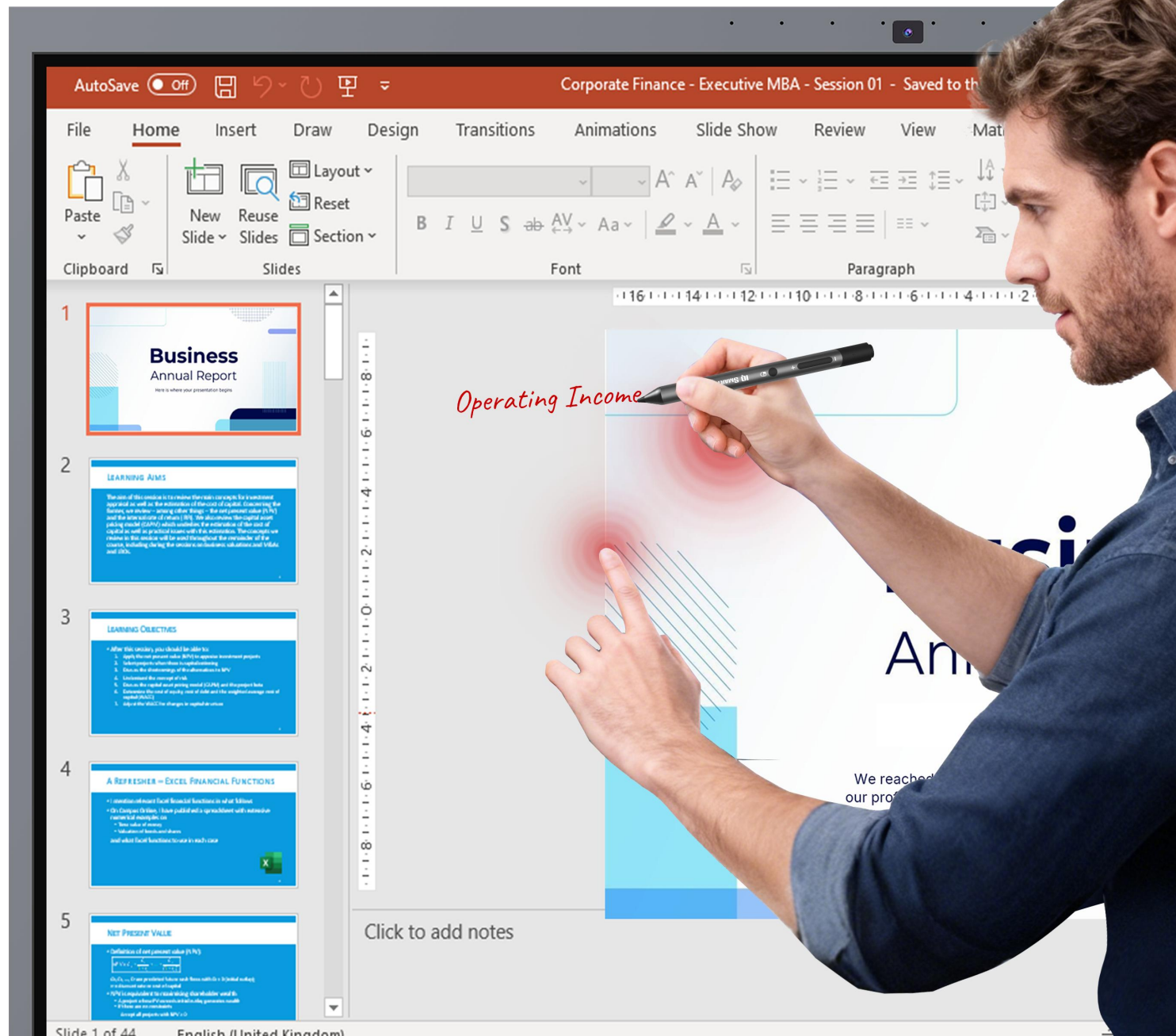

AI-Powered 4K Camera for Every Meeting

The QA1400 Pro features a 64MP AI camera with smart functions including auto-framing, voice-tracking and multi-participant mode. Switch between AI camera modes effortlessly with simple gestures, while eight far-field built-in microphones capture every voice clearly, delivering a virtual meeting experience as natural and immersive as face-to-face interaction.



Auto-framing



Voice Tracking



Multiple Participants



Gesture Recognition

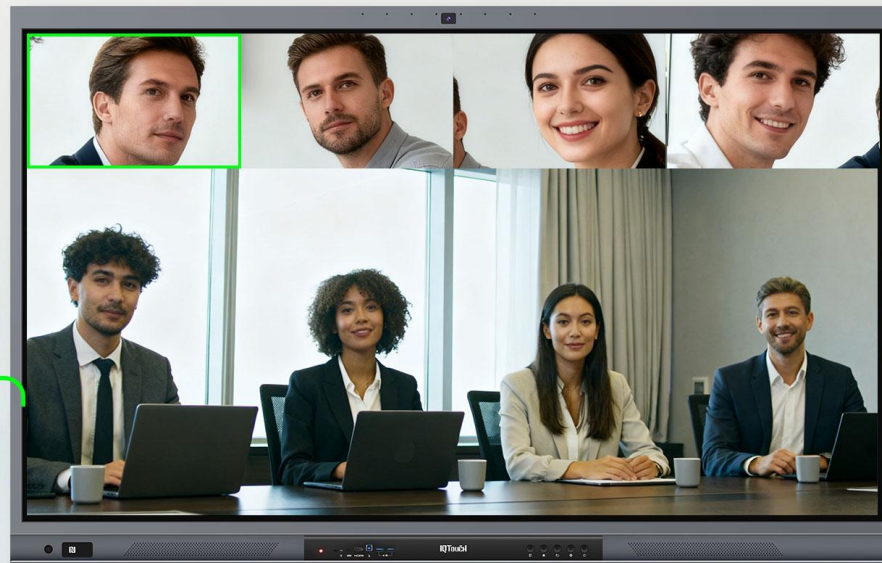

4K BYOD Made Effortless with Wi-Fi 6

Experience effortless sharing and collaboration with 4K BYOD, allowing anyone to cast ultra-clear content from any device. Powered by dual independent Wi-Fi 6 modules, the QA1400 Pro delivers fast, stable and interference-free connectivity—streaming, downloading and wireless casting all run smoothly at the same time. High-resolution visuals and high-speed performance come together to elevate every lesson and meeting.

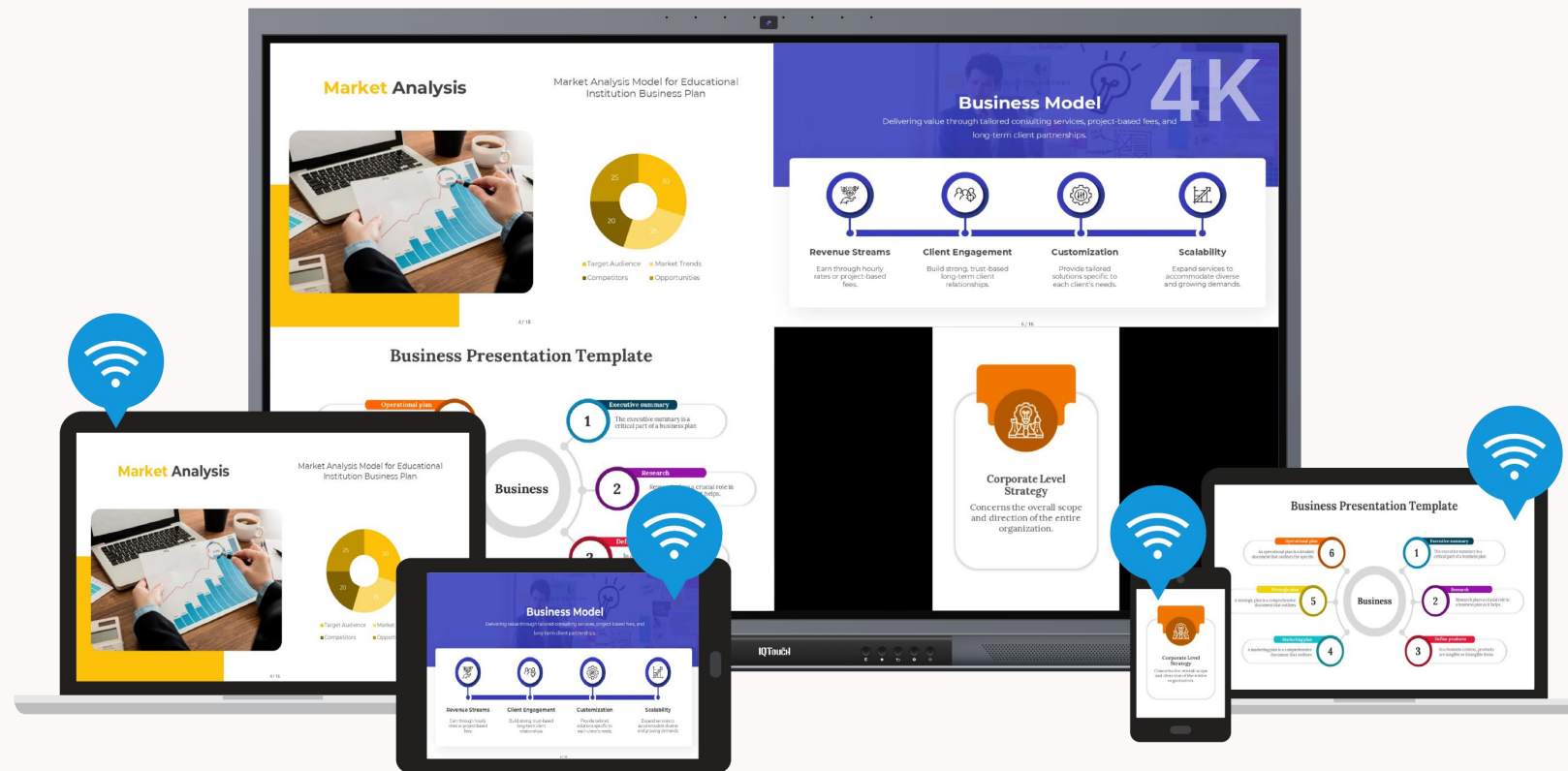

Wi-Fi 6-Powered Remote Collaboration, without Boundaries



Remote screen sharing across networks (Broadcast)

Students can view QA1400 Pro content on their own devices seamlessly via browser in real time, no matter where they are. Perfect for remote study sessions or hybrid classes who cannot attend in-person classes and cannot see screen content.

Wi-Fi 6 turbocharges real-time sharing with higher bandwidth, lower latency and stronger stability—ensuring smooth, uninterrupted interaction even when users connect from different networks or locations.



Remote screen projection across networks (Webcast)

Participants can share their own screens to the QA1400 Pro from anywhere via a browser. This makes long-distance meeting and collaboration easy and interactive—no physical presence required.

BYOM

Bring Your Own Meeting

With BYOM (Bring Your Own Meeting) support, connect your personal device and instantly access the panel's camera, microphone and speakers — without installing additional drivers. Your favorite conferencing platform, your way.



Centralized Control, Smarter Management

With Remote Device Management (DMS), administrators can oversee every QA1400 Pro display from a single platform—monitoring status, pushing updates and adjusting settings instantly. It streamlines maintenance and keeps every classroom display running smoothly with minimal effort.

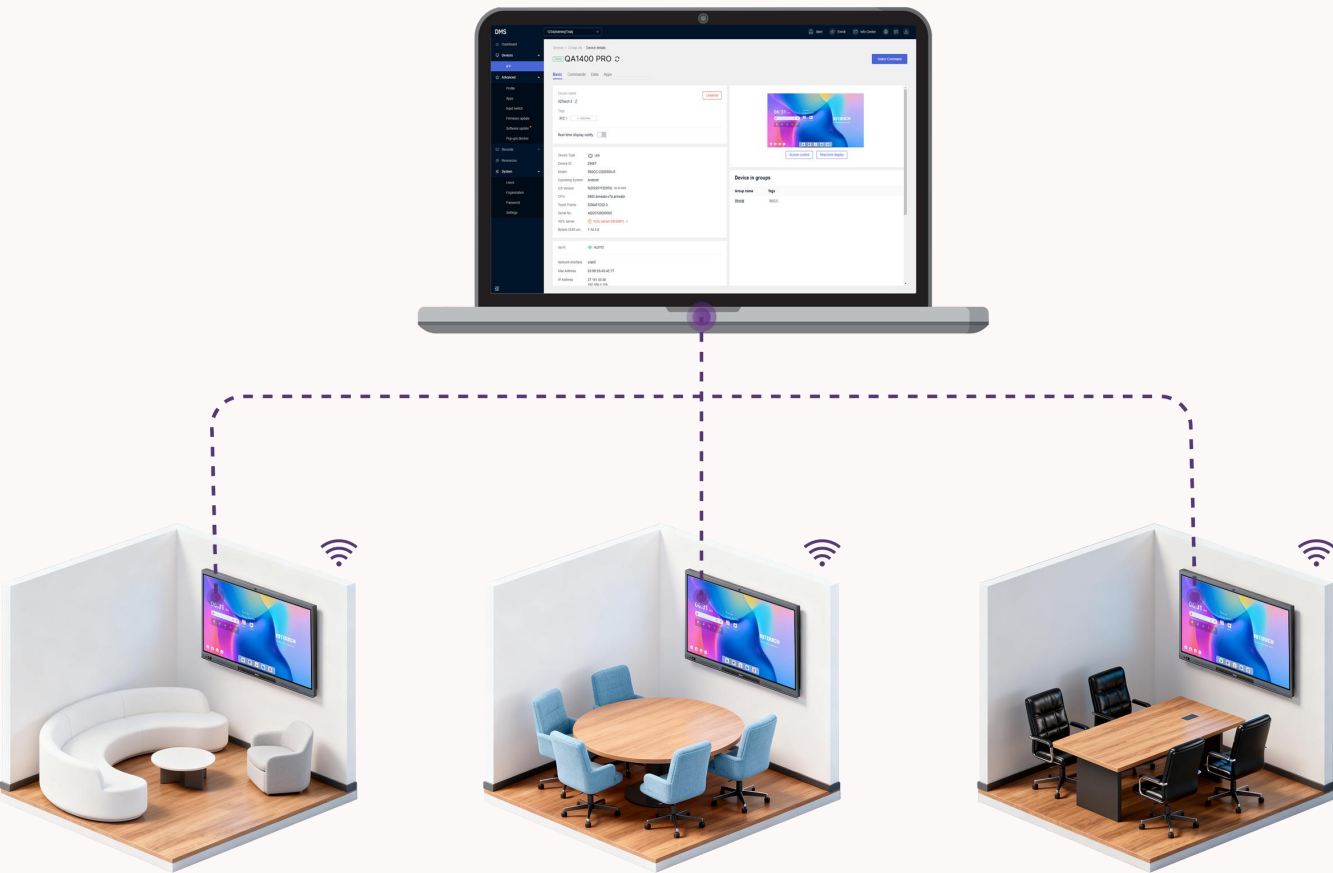

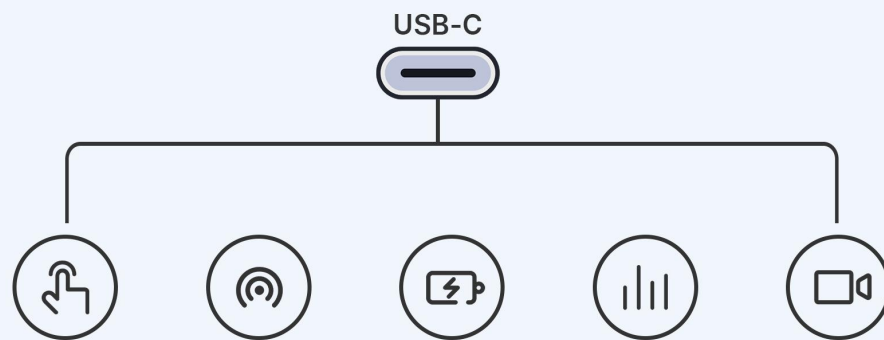

Plug & Play USB-C

Simplify your classroom setup with a single USB-C cable that handles touch control, LAN sharing, 100W fast charging, audio and 4K@60fps video transmission. Fully compatible with laptops, tablets and smartphones, the QA1400 Pro lets educators start presentations instantly, reducing setup time and eliminating technical stress. Seamless, fast and intuitive, it makes every lesson effortless and productive.

- Soulmates for IQTouch - IQ SmartPen

**The smart assistance for
your presentation**

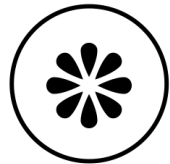

Color Switch

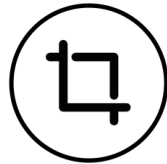

Screenshot

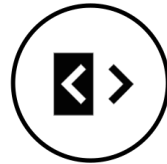

Wireless Presenter



Blackboard

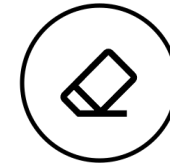

Eraser



Annotation

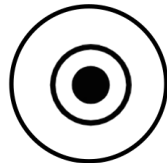

Digital Laser Pointer



Hyperlink

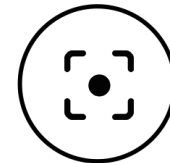

Spotlight

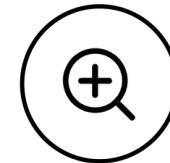

Magnifier

- Soulmates for IQTouch - OPS



Use your familiar Windows OS on the IFP

Pre-install IQClass One whiteboard software
with activated license.

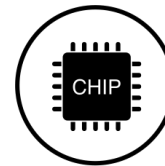

Chipset
Intel

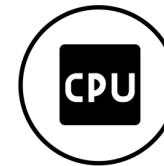

CPU
Intel®Core i7, 10th Gen

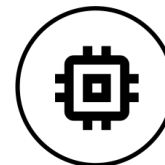

Memory
8GB



SSD
512GB

- Soulmates for IQTouch - IQShare Button C5



Share your screen with a click of a button

*USB-C & HDMI button available for choice

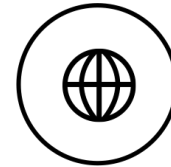

No network requirement

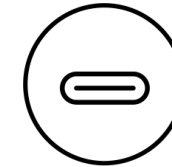

USB-C button for 4K wireless casting



Driver free



BYOM

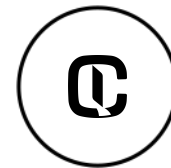

CustomizableQ Button

- Soulmates for IQTouch - IQSound SA200



Enjoy the immersive sound effect

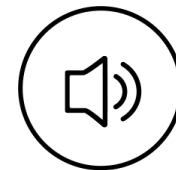

80W output

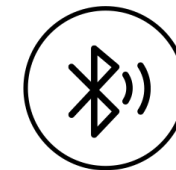

Bluetooth 5.0

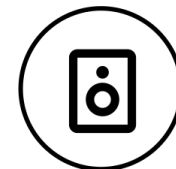

4*full-range speakers
2*tweeters

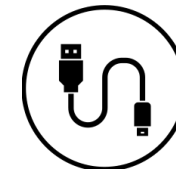

Wired and wireless
connection

- Soulmates for IQTouch - Mobile Stand



**Move around your IFP
freely for flexible use**

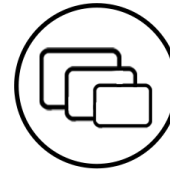

Suitable for 55"-86"

Specifications IQTouch QA1400 PRO



Display					
Model	LE065MD	LE075MD	LE086MD	LE098MD	LE110MD
Diagonal Size	65"	75"	86"	98"	110"
Backlight	Direct LED(DLED)				
Panel Type	TFT				
Display Ratio	16:9				
Resolution	4K UHD(3840*2160)				
Brightness	400cd/m ²				
Dynamic Contrast Ratio	4000: 1				
Contrast Ratio	1200: 1				
Response Rate	8ms(typ.)				
Refreshing Frequency	60Hz				
Viewing Angle	178° (H), 178° (V)				
Glass	3.2mm Hardened Anti-Reflection Safety Glass(8H)				
Backlight Life Time	50,000 hrs				
Display Colors	10bit(D), 1.07Billion colors				

Interactivity	
LE065MD/LE075MD/LE086MD/LE098MD/LE110MD	
Touch Technology	Infrared
Touch Point	50-point touch 50-point writing under Windows 20-point writing under Android
Touch Resolution	32768*32768(px)
Response Rate	<4ms(single touch) <6ms(max touch inputs)
Touch Accuracy	≤1mm
Recognition	Finger or pen
Writing Height	3mm
Minimum Touch Object	1.5mm
Supported O.S.	HID Support& Win10/Win8/Win7/Mac OS/Android/Chrome OS/Linux

Front Buttons	
Front Buttons	POWER, HOME, BACK, SETTING, CUSTOM

Connectivity			
Front	USB 3.0(Android& PC)	2	
	HDMI IN 2.0	1	
	Touch-USB	1	
	TYPE-C(USB 2.0& Video& Audio& Touch& 65W)	1	
Input	RJ45(10/100/1000 Mbit/s)	1	
	HDMI 2.0(4K@60fps)	2	
	TYPE-C(USB 2.0& Video& Audio& Touch& 100W)	1	
	USB 2.0(Android) Type-A	1	
	USB 3.0(Android& PC) Type-A	2	
	USB 3.0(for Touch) Type B	2	
	VGA	1	
	VGA Audio	1	
	RS232	1	
	DP	1	
	Output	HDMI 2.0(4K@60fps)	1
		OPTICAL SPDIF OUT	1
EARPHONE(3.5 mm Line Out)		1	
RJ45(10/100/1000 Mbit/s)		1	

Function	
Built-in Speaker	20W*2+20W
Light Sensitivity	YES
Temperature Monitor	YES
Proximity Sensor	YES
Built-in Camera	64MP(Built-in Pre -Video 4K AI Camera with Auto Framing& Voice Tracking& Multi-Participants)
Array Microphone	YES(8 Array microphone)
Hotspot	IEEE 802.11 a/b/g/n/ac/ax, IEEE 802.1x, WPA2, station mode(2.4G/5G Dual-band)
Bluetooth	5.2
WiFi	IEEE 802.11 a/b/g/n/ac/ax, IEEE 802.1x, WPA2, Wi-Fi6 and station mode(2.4G/5G Dual-band)
NFC	YES
Air sensors	Temperature, Humidity, PM2.5, VOC
IQ OS	IQ-EDLA

Android	
CPU Framework	Cortex-A73*4 + Cortex-A53*4
CPU Processor Speed	2.2GHz
GPU	Arm Mali-G52 MP8(8EE)
RAM	8G
ROM	128G
OS Version	Android 14.0
Screensharing	EShare Pro
Device Management	Bytello DMS

Environment	
Working Temperature	0°C ~ 40°C
Storage Temperature	-20°C ~ 60°C
Working Humidity	20% ~ 80% RH Non-Condensing
Storage Humidity	20% ~ 90% RH Non-Condensing

OPS (Optional)	
Chipset	Intel
CPU	Intel®Core i3/i5/i7
Memory	4GB/8GB/16GB
HDD	500GB/1TB
SSD(optional)	128GB/256GB/512GB
Pre-installed Software	IQCLASS ONE, IQVIEW, IQCLICK
Interfaces (Subject to model)	USB 2.0 x 2 USB 3.0 x 2 LAN x 1 HDMI x 1 LINE-OUT x 1 MIC-IN x 1

Power					
	LE065MD	LE075MD	LE086MD	LE098MD	LE110MD
Voltage	100V~240V AC 50/60Hz				
Maximum Power	≤350W	≤350W	≤450W	≤650W	≤750W
Standby Power	≤0.5W				

Physical					
	65"	75"	86"	98"	110"
Net Weight (kg)	40±1.5	56±1.5	66±1.5	106±1.5	128±1.5
Gross Weight (kg)	46±1.5	70±1.5	81±1.5	121±1.5	153±1.5
Product Size (mm)(W*H*D)	1501*930*87	1723*1055*87	1968*1194*87	2233*1346*105	2517*1507*105
Packing Size (mm)(W*H*D)	1576*980*200	1800*1125*200	2044*1262*200	2306*1520*200	2665*1595*298
VESA Hole Position(mm)	4-M8 screw hole 500*400	4-M8 screw hole 600*400	4-M8 screw hole 800*400	4-M8 screw hole 1000*400	4-M8 screw hole 1000*400

Language	
OSD	English, Simplified Chinese, French, German, Spanish, Italian, Russian, Polish, Dutch, Swedish, Czech, Danish, Portuguese, Portuguese(Brazilian), Finnish, Korean, Traditional Chinese, Thai, Indonesian, Arabic, Catalan(Spanish), Norwegian, Greek, Hungarian, Romanian, Turkish, Ukrainian, Basque, Kazakh, Lithuanian, Estonian, Japanese, Hebrew

Accessories	
Power Cord	1(1.5m)
HDMI Cable	1(1.5m)
USB Cable	1(1.5m)
Remote Controller	1
NFC Card	1
Colorless Writing Pen	2
Wall Mounting Brackets	1

Certificate
CE, FCC, ROHS, BIS, IEC, WEEEEE, Energy Star, CB, IECEE, TUV Low blue light, ERP

Warranty
Warranty term and upgrade options vary by region. Contact your local reseller or distributor for information

IQTOUCH



Returnstar Interactive Technology Group CO., LTD.

📍 6th Bldg. High-Tech Base. Fuzhou Fujian Prov. China

🌐 IQBoard.net | Qnextech.com ☎ 0086-591-38202660

✉ IQBoard@IQBoard.net 📠 0086-591-38203003

